



ESSENTIAL

by SCRIGNO®

 **ESSENTIAL**
by **SCRIGNO**



EE

La differenza tra



The difference between





apparire ed essere



seeming to be and being



Libera la parete, libera il progetto *Free the wall, free the project*

Essential by Scigno è il marchio che contraddistingue la nuova linea di porte a battente e i controtelai Essential ed Essential Dual, i sistemi scorrevoli brevettati in esclusiva da Scigno.

I prodotti della linea Essential aprono nuovi sviluppi per tutte le soluzioni di arredo. Non più semplici soluzioni per la gestione di accessi e passaggi, ma veri e propri strumenti di interior design per l'arredo. Frutto delle ricerche sugli stili abitativi e sulle aspettative dei consumatori, Scigno si ripropone come marchio leader nel proprio settore.

Il design ha eliminato tutti gli elementi esterni, riducendo al minimo la parte di finitura fuori muro. Sia fisicamente che visivamente, la parete si presenta libera da stipiti e altre finiture, lasciando alle aperture tra un ambiente e l'altro la massima continuità e fluidità: il vano porta sembra tagliato nel muro, creando ambienti di sicuro impatto estetico.

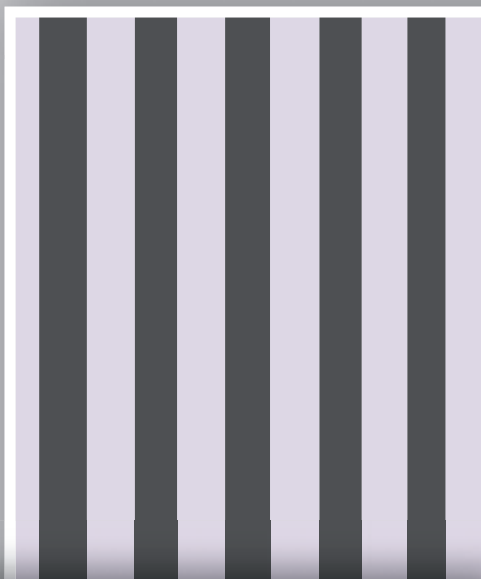

Essential by Scigno is the name that identifies the new range of swinging doors and the Essential and Essential Dual frames, with sliding systems patented exclusively by Scigno.

The products of the Essential range open new possibilities for all decor styles, offering not just simple and practical solutions for door openings but nothing less than true instruments for interior design. From its research into living trends and consumer expectations, Scigno confirms itself once again as the leader in its market sector.

The design process has eliminated all external components, reducing finishing elements exposed outside the wall to a minimum. Both physically and visually the wall is free from door posts, edgings and all other parts, giving the opening between the two spaces the greatest possible continuity and fluidity. The door opening seems cut directly into the wall, creating an environment of striking aesthetic impact.

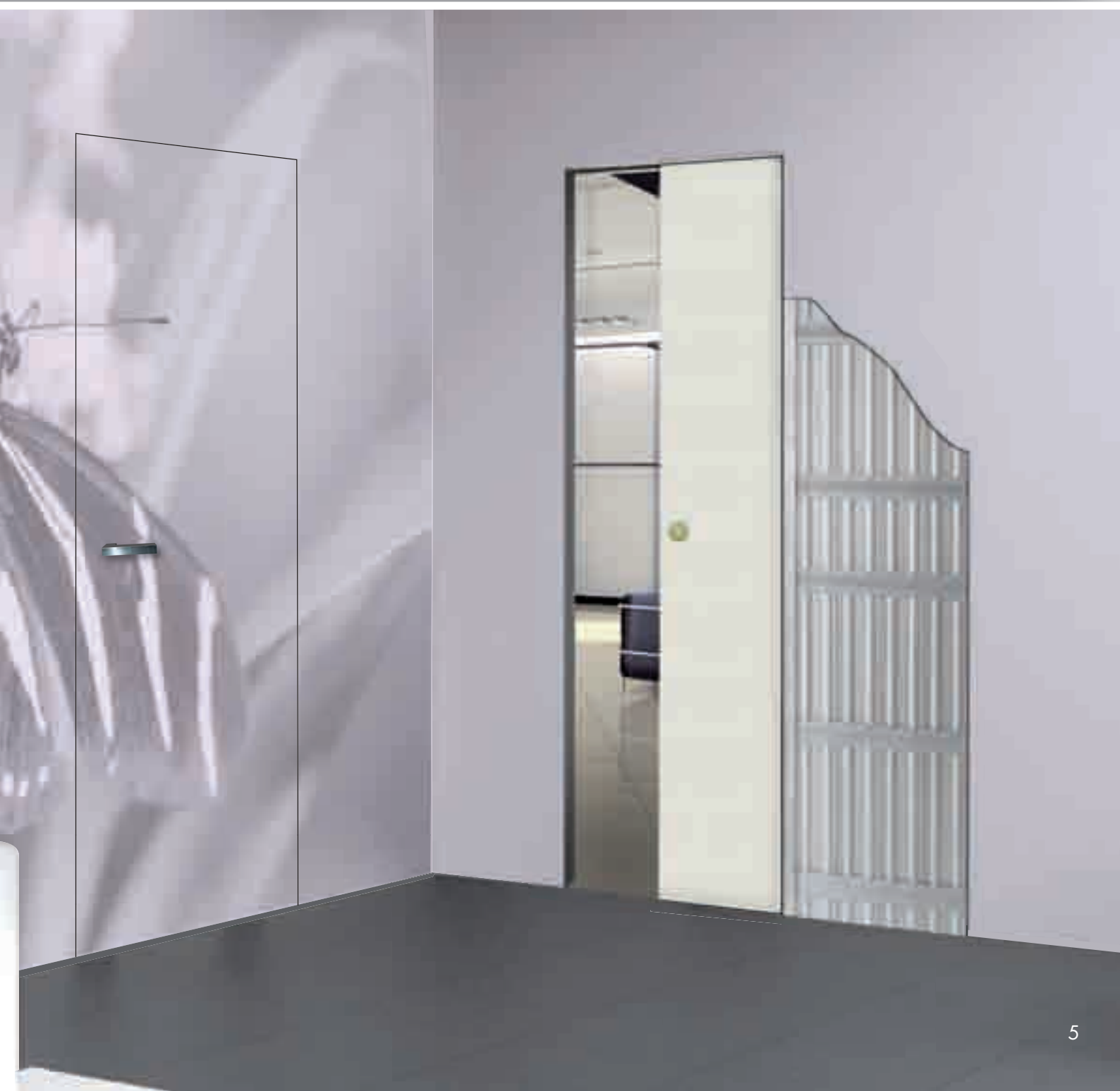

I controtelai: due brevetti esclusivi

The frames: two exclusive patents

Scrigno Essential è il controtelaio per interni, risultato dell'attenzione di Scrigno per l'innovazione tecnologica e per il servizio. Con Essential si è voluto valorizzare e far cogliere pienamente il design di un interno: il controtelaio è stato realmente ridotto all'essenziale. Sono stati sostituiti il montante in legno, gli incastri per gli stipiti, le cornici coprifilo con dei profili in alluminio grezzo, da tinteggiare nella stessa finitura del muro, consentendo una completa fusione della porta con la parete che risulta libera da ogni finitura.

Dall'evoluzione dei controtelai Essential e Granluce, nasce Essential Dual, un prodotto innovativo, che permette di contenere al suo interno due porte in vetro scorrevoli a scomparsa collegate tra loro da un sistema di trascinamento. Essential Dual rappresenta un importante completamento del controtelaio Essential, quest'ultimo già ampiamente utilizzato e apprezzato dai progettisti per la sua linearità ed essenzialità. Le ante in vetro rappresentano una ulteriore possibilità d'arredo. La parete come per il controtelaio Essential è pulita, libera da stipiti e altre finiture.



Scrigno Essential is a frame for interiors, the result of Scrigno's attention to technological innovation and service. The aim of Essential is to enhance and fully emphasize the surrounding interior design, and the frame has truly been reduced to the essential minimum.

The wooden upright, joints for door posts and edging trims have been replaced with coarse-finished aluminium profile sections that can be painted in the same colour as the wall, allowing the door to merge seamlessly with the wall, now free from all superfluous elements.

Essential Dual is an evolution of the Essential and Granluce frames, and is an innovative product that can contain two disappearing glass doors with a linked sliding system. Essential Dual is an important complement to the Essential frame, already widely used and appreciated by designers for its clean and linear styling. The glass doors give even greater opportunity for exciting interior design solutions, and as with the Essential frame, the wall remains plain and clean, free from door posts and all other components.





Le porte a battente filo parete *Swinging doors flush with the wall*

I prodotti della gamma Essential si completano con le nuove porte della linea a battente; un sistema di porte a filo parete che non necessitano di cornice coprifilo. La porta si confonde sempre di più con l'ambiente circostante, creando continuità tra le pareti che, diventano le protagoniste indiscusse dello spazio mentre la porta si percepisce completamente "fusa" con il muro.

La particolarità delle porte Essential a battente è la possibilità di dar continuità agli ambienti, i pannelli porta possono essere verniciati, laccati o ricoperti con carte da parati esattamente come le finiture già esistenti. Inoltre c'è la possibilità di rifinire la porta in due modi diversi, uno per ogni lato permettendo di adattarsi all'ambiente in cui è inserita.

The products of the Essential range are completed by a new line of swinging doors, featuring doors flush with the wall that need no edging trims. The door blends even more integrally into its surroundings, creating continuity with the walls, which become the unmistakable protagonists of the space, while the door is perceived as being totally amalgamated into the wall.

The distinctive feature of Essential swinging doors is their possibility of giving continuity to environments, and door panels can be painted, lacquered or covered with wallpaper, exactly like the finishes already existing. The door can even be finished differently on each side, adapting it perfectly to the space of which it is part.



Le porte della linea Essential filo parete sono disponibili in due varianti: Essential Battente, che presenta la classica fuga tra anta e telaio ed Essential Battente Zero, che rappresenta la versione senza fuga.

Le porte Essential possono essere installate sia in pareti in muratura che in cartongesso e possono essere realizzate sia nella classica forma rettangolare sia nella particolare forma trapezoidale che ben si adatta ad ambienti particolari (ad esempio sottotetti, sottoscala...). La forma trapezoidale non è disponibile nella variante Battente Zero.



Essential flush doors are available in two versions: Essential Battente, with the classic slight gap between door and frame, and Essential Battente Zero, the gapless version.

Essential doors can be fitted on both masonry and plasterboard walls, and can be made in either the classic rectangular form or in special trapezoidal shapes (for use in lofts, beneath stairs, etc). The trapezoidal shape is not available for the Battente Zero version.



Piccoli Vani

Small Spaces

Essential Little e Little Zero rappresentano un sistema di sportelli a filo parete che non richiedono l'utilizzo di cornici coprifilo, con cerniere a scomparsa con aperture a 90°. Pensati come chiusure speciali per vani, sono la soluzione ideale per creare armadi, richiudere ripostigli, quadri elettrici, impianti ecc... I modelli della linea Little presentano la classica fuga tra lo sportello e il telaio. È disponibile anche la variante Little Zero, la versione che non presenta la fuga. Sono disponibili in diverse forme verticali e orizzontali, rettangolari o trapezoidali. La forma trapezoidale non è disponibile nella variante Little Zero. Il pannello dello sportello può essere verniciato, laccato o ricoperto con carte da parati esattamente come le finiture già esistenti, mimetizzandosi con l'ambiente circostante. Essential Little e Little Zero possono essere installate in pareti di qualsiasi spessore sia in muratura sia in cartongesso. Tre le aperture disponibili: laterale, a ribalta e a vasistas.

Sono disponibili anche particolari chiusure, botole e sportelli d'ispezione, nate specificatamente per le pareti in cartongesso. Realizzati interamente in cartongesso (telaio e coperchio) si possono montare verticalmente o orizzontalmente esclusivamente in pareti di cartongesso. Il pannello di chiusura può essere verniciato, laccato o ricoperto con carte da parati fondendosi con l'ambiente e scomparendo praticamente dalla vista. Tre i modelli disponibili: con coperchio e agganci magnetici senza cerniere, con cerniere con apertura a 90°, con apertura a soffitto con coperchio rimovibile verso l'interno (solo per botole a soffitto).



Essential Little and Little Zero are flush doors that need no edging trims, and open through 90° on concealed hinges. Designed as special doors for closing small spaces, they are the ideal solution to create wardrobes, close storage recesses and hide electrical panels, utility systems, etc. The models of the Little range have the classic small gap between the frame and the door, while the Little Zero version has no gap. These doors are available in various vertical and horizontal forms, either rectangular or trapezoidal in shape. Trapezoidal shapes are not available for the Little Zero version. The door can be painted, lacquered or covered with wallpaper, allowing it to be perfectly matched with its surroundings. Essential Little and Little Zero can be installed on walls of any thickness in both masonry and plasterboard, and can be hinged for opening from the sides, upwards or downwards.

A variety of special closures, trapdoors and inspection hatches have been designed for fitting on plasterboard walls. Made entirely from plasterboard (frame and cover), these accessories can be installed vertically or horizontally in plasterboard walls only. The closure panel can be painted, lacquered or covered with wallpaper, blending into their surroundings and becoming practically invisible. Three models are available, with cover and magnetic catches without hinge, with hinge opening through 90°, and with ceiling opening with cover removable towards the interior (for ceiling trapdoors only).



CONTRATELAI
COUNTERFRAMES



È il controtelaio nato dalla collaborazione con il designer Piero Esposito e brevettato in esclusiva da Scrigno. Il sistema consente la scomparsa di una porta scorrevole armonizzandosi con la parete che risulta libera da ogni finitura. Il telaio è stato ridotto all'essenziale, eliminando stipiti e cornici coprifilo. Sono stati adottati profili di alluminio, sui quali viene direttamente rasato l'intonaco, o il cartongesso: la semplice tinteggiatura dei profili, come la parete completa il risultato estetico.

È disponibile nelle versioni anta unica e anta doppia, per pareti in muratura e cartongesso.
Disponibile anche in versione fuori misura con altezze variabili al centimetro.

This frame created with the collaboration of designer Piero Esposito was patented as an exclusive by Scrigno, and is a system that allows a sliding door to completely disappear, perfectly matching the wall and leaving it free from all exposed components.

The frame has been reduced to the minimum by eliminating the doorpost and surround strips. Plasterwork or plasterboard is applied directly to the aluminium profile bars, which can then easily be painted, along with the walls, to give attractive final results.

Available in one and two-door versions and for masonry and plasterboard walls.

Also available in non-standard sizes, in heights varying to the nearest centimetre.

ESSENTIAL SCORREVOLE - SLIDING

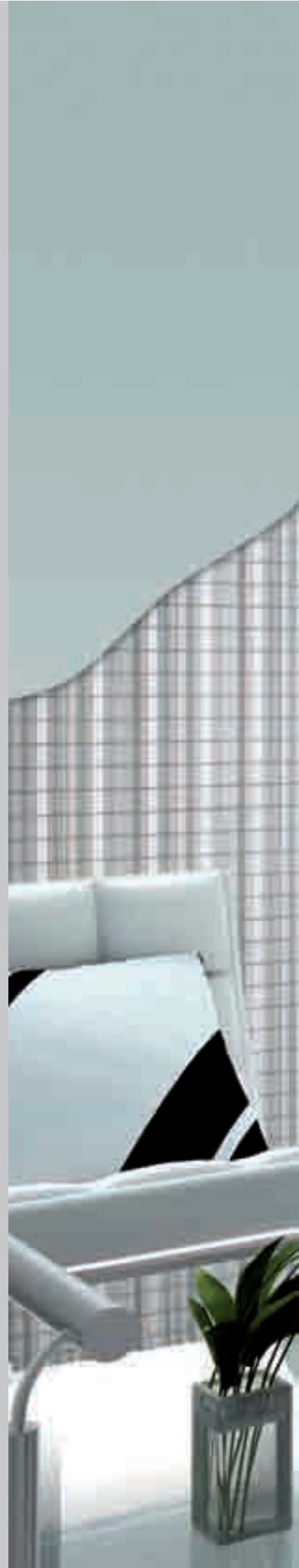





SCORREVOLE SINGOLO
SLIDING SINGLE

ESSENTIAL

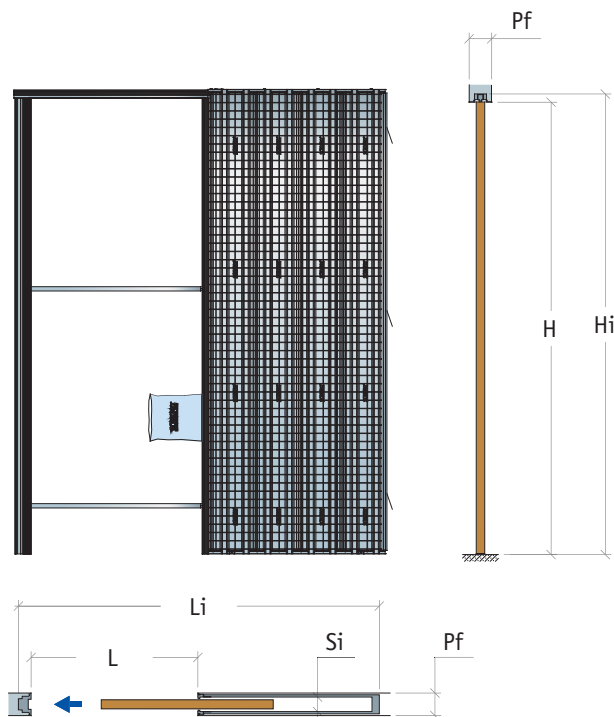
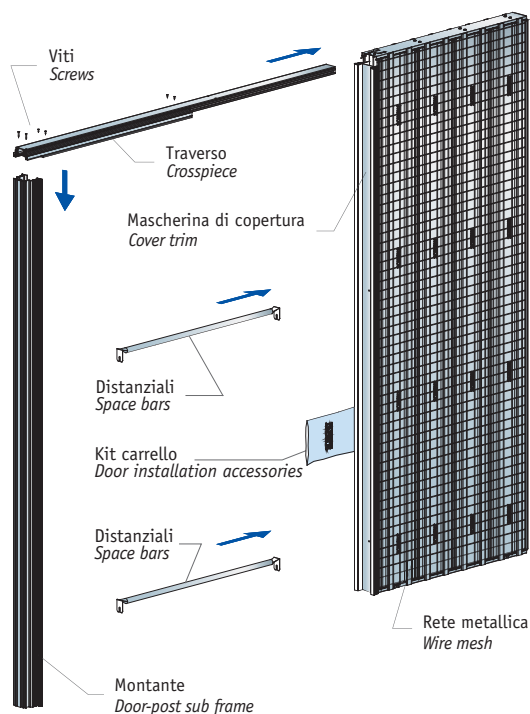

ANTA UNICA PER PARETI INTONACABILI FOR PLASTERED WALLS, SINGLE

PER INTONACO FOR PLASTERED WALLS

anta unica
single

Luce di passaggio "L x H" Clear opening size "L x H"	Misure d'ingombro "Li x Hi" Structural opening size "Li x Hi"	Parete finita/Sede interna "Pf x Si" Finished wall/Internal space "Pf x Si"
600 x 2000	1320 x 2065	105/69 - 125/89
600 x 2100	1320 x 2165	105/69 - 125/89
700 x 2000	1520 x 2065	105/69 - 125/89
700 x 2100	1520 x 2165	105/69 - 125/89
750 x 2000	1620 x 2065	105/69
750 x 2100	1620 x 2165	105/69
800 x 2000	1720 x 2065	105/69 - 125/89
800 x 2100	1720 x 2165	105/69 - 125/89
900 x 2000	1920 x 2065	105/69 - 125/89
900 x 2100	1920 x 2165	105/69 - 125/89
1000 x 2000	2120 x 2065	105/69 - 125/89
1000 x 2100	2120 x 2165	105/69 - 125/89
1100 x 2000	2320 x 2065	105/69 - 125/89
1100 x 2100	2320 x 2165	105/69 - 125/89
1200 x 2000	2520 x 2065	105/69 - 125/89
1200 x 2100	2520 x 2165	105/69 - 125/89

PER INTONACO FUORI MISURA FOR EXTRA HEIGHT PLASTERED WALLS

anta unica
single

Luce di passaggio "L x H" Clear opening size "L x H"	Misure d'ingombro "Li x Hi" Structural opening size "Li x Hi"	Parete finita/Sede interna "Pf x Si" Finished wall/Internal space "Pf x Si"
600 x 800÷1990	1320 x 865÷2055	105/69 - 125/89
600 x 2010÷2090	1320 x 2075÷2155	105/69 - 125/89
700 x 800÷1990	1520 x 865÷2055	105/69 - 125/89
700 x 2010÷2090	1520 x 2075÷2155	105/69 - 125/89
800 x 800÷1990	1720 x 865÷2055	105/69 - 125/89
800 x 2010÷2090	1720 x 2075÷2155	105/69 - 125/89
900 x 800÷1990	1920 x 865÷2055	105/69 - 125/89
900 x 2010÷2090	1920 x 2075÷2155	105/69 - 125/89
1000 x 800÷1990	2120 x 865÷2055	105/69 - 125/89
1000 x 2010÷2090	2120 x 2075÷2155	105/69 - 125/89
1100 x 800÷1990	2320 x 865÷2055	105/69 - 125/89
1100 x 2010÷2090	2320 x 2075÷2155	105/69 - 125/89
1200 x 800÷1990	2520 x 865÷2055	105/69 - 125/89
1200 x 2010÷2090	2520 x 2075÷2155	105/69 - 125/89

PER INTONACO FUORI MISURA FOR EXTRA HEIGHT PLASTERED WALLS

anta unica
single

Luce di passaggio "L x H" Clear opening size "L x H"	Misure d'ingombro "Li x Hi" Structural opening size "Li x Hi"	Parete finita/Sede interna "Pf x Si" Finished wall/Internal space "Pf x Si"
600 x 2110÷2700	1320 x 2175÷2765	105/69 - 125/89
700 x 2110÷2700	1520 x 2175÷2765	105/69 - 125/89
800 x 2110÷2700	1720 x 2175÷2765	105/69 - 125/89
900 x 2110÷2700	1920 x 2175÷2765	105/69 - 125/89
1000 x 2110÷2700	2120 x 2175÷2765	105/69 - 125/89
1100 x 2110÷2700	2320 x 2175÷2765	105/69 - 125/89
1200 x 2110÷2700	2520 x 2175÷2765	105/69 - 125/89

Prima di ordinare la porta per il contro telaio Essential è necessario verificare in cantiere l'effettiva misura della luce. Essa si rileva ad installazione avvenuta del contro telaio.

Before ordering the door for the Essential frame, the effective clear opening size must be checked onsite. This must be measured after the installation of the frame.

La luce di passaggio effettiva è ridotta in larghezza di mm 10 - The effective clear opening size is reduced in width by 10 mm

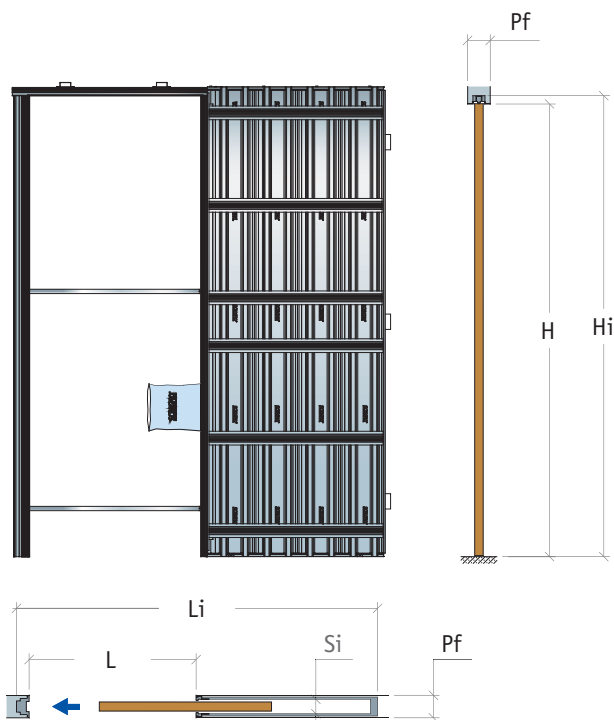
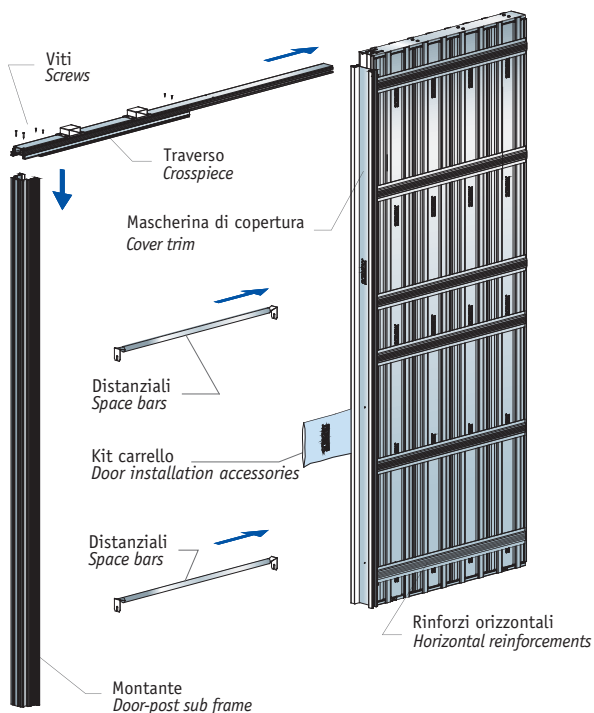

ANTA UNICA PER PARETI IN CARTONGESSO FOR PLASTERBOARD WALLS, SINGLE

PER CARTONGESSO
FOR PLASTERBOARD WALLS

anta unica
single

Luce di passaggio "L x H" Clear opening size "L x H"	Misure d'ingombro "Li x Hi" Structural opening size "Li x Hi"	Parete finita/Sede interna "Pf x Si" Finished wall/Internal space "Pf x Si"
600 x 2000	1320 x 2065	100/54 - 125/69
600 x 2100	1320 x 2165	100/54 - 125/69
700 x 2000	1520 x 2065	100/54 - 125/69
700 x 2100	1520 x 2165	100/54 - 125/69
750 x 2000	1620 x 2065	125/69
750 x 2100	1620 x 2165	125/69
800 x 2000	1720 x 2065	100/54 - 125/69
800 x 2100	1720 x 2165	100/54 - 125/69
900 x 2000	1920 x 2065	100/54 - 125/69
900 x 2100	1920 x 2165	100/54 - 125/69
1000 x 2000	2120 x 2065	100/54 - 125/69
1000 x 2100	2120 x 2165	100/54 - 125/69
1100 x 2000	2320 x 2065	125/69
1100 x 2100	2320 x 2165	125/69
1200 x 2000	2520 x 2065	125/69
1200 x 2100	2520 x 2165	125/69

LEGENDA LEGEND

- L = Larghezza luce
Opening Width
- H = Altezza luce
Opening Height
- Li = Ingombro in larghezza
Overall Width
- Hi = Ingombro in altezza
Overall Height
- Pf = Parete finita
Finished Wall
- Si = Sede interna
Internal Space

PER CARTONGESSO FUORI MISURA
FOR EXTRA HEIGHT PLASTERBOARD WALLS

anta unica
single

Luce di passaggio "L x H" Clear opening size "L x H"	Misure d'ingombro "Li x Hi" Structural opening size "Li x Hi"	Parete finita/Sede interna "Pf x Si" Finished wall/Internal space "Pf x Si"
600 x 800÷1990	1320 x 865÷2055	100/54 - 125/69
600 x 2010÷2090	1320 x 2075÷2155	100/54 - 125/69
700 x 800÷1990	1520 x 865÷2055	100/54 - 125/69
700 x 2010÷2090	1520 x 2075÷2155	100/54 - 125/69
800 x 800÷1990	1720 x 865÷2055	100/54 - 125/69
800 x 2010÷2090	1720 x 2075÷2155	100/54 - 125/69
900 x 800÷1990	1920 x 865÷2055	100/54 - 125/69
900 x 2010÷2090	1920 x 2075÷2155	100/54 - 125/69
1000 x 800÷1990	2120 x 865÷2055	100/54 - 125/69
1000 x 2010÷2090	2120 x 2075÷2155	100/54 - 125/69
1100 x 800÷1990	2320 x 865÷2055	125/69
1100 x 2010÷2090	2320 x 2075÷2155	125/69
1200 x 800÷1990	2520 x 865÷2055	125/69
1200 x 2010÷2090	2520 x 2075÷2155	125/69

PER CARTONGESSO FUORI MISURA
FOR EXTRA HEIGHT PLASTERBOARD WALLS

anta unica
single

Luce di passaggio "L x H" Clear opening size "L x H"	Misure d'ingombro "Li x Hi" Structural opening size "Li x Hi"	Parete finita/Sede interna "Pf x Si" Finished wall/Internal space "Pf x Si"
600 x 2110÷2400	1320 x 2175÷2465	125/69
700 x 2110÷2400	1520 x 2175÷2465	125/69
800 x 2110÷2400	1720 x 2175÷2465	125/69
900 x 2110÷2400	1920 x 2175÷2465	125/69
1000 x 2110÷2400	2120 x 2175÷2465	125/69
1100 x 2110÷2400	2320 x 2175÷2465	125/69
1200 x 2110÷2400	2520 x 2175÷2465	125/69

Prima di ordinare la porta per il contro telaio Essential è necessario verificare in cantiere l'effettiva misura della luce. Essa si rileva ad installazione avvenuta del contro telaio.

Before ordering the door for the Essential frame, the effective clear opening size must be checked onsite. This must be measured after the installation of the frame.

La luce di passaggio effettiva è ridotta in larghezza di mm 10 - The effective clear opening size is reduced in width by 10 mm

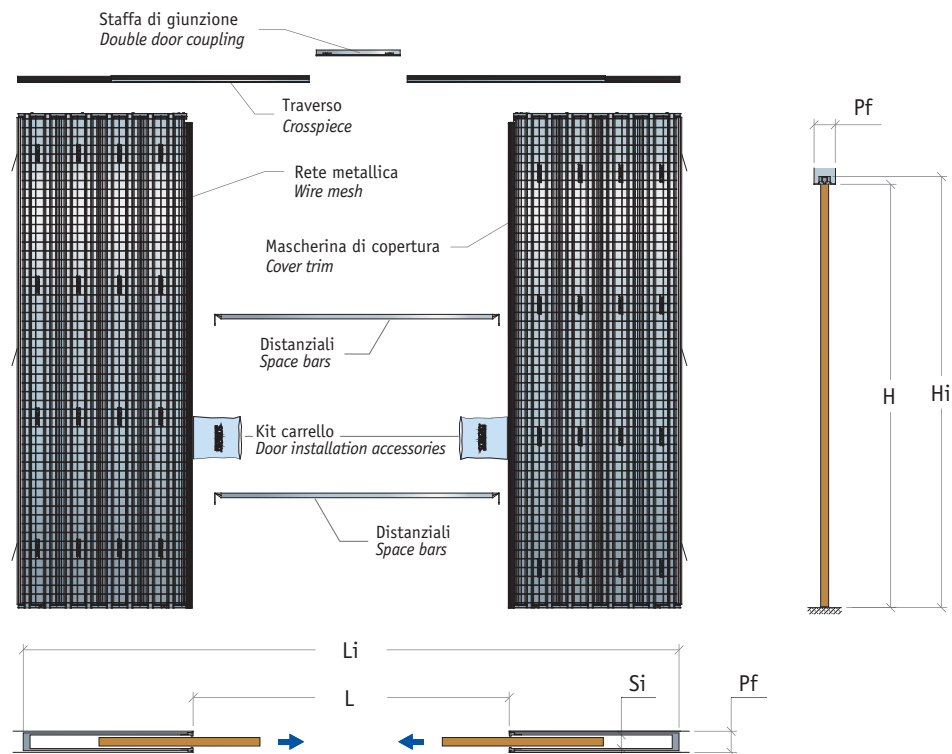

ANTA DOPPIA PER PARETI INTONACABILI FOR PLASTERED WALLS, DOUBLE

PER INTONACO FOR PLASTERED WALLS		anta doppia double
Luce di passaggio "L x H" Clear opening size "L x H"	Misure d'ingombro "Li x Hi" Structural opening size "Li x Hi"	Parete finita/Sede interna "Pf x Si" Finished wall/Internal space "Pf x Si"
1200 x 2000	2520 x 2065	105/69 - 125/89
1200 x 2100	2520 x 2165	105/69 - 125/89
1400 x 2000	2920 x 2065	105/69 - 125/89
1400 x 2100	2920 x 2165	105/69 - 125/89
1600 x 2000	3320 x 2065	105/69 - 125/89
1600 x 2100	3320 x 2165	105/69 - 125/89
1800 x 2000	3720 x 2065	105/69 - 125/89
1800 x 2100	3720 x 2165	105/69 - 125/89
2000 x 2000	4120 x 2065	105/69 - 125/89
2000 x 2100	4120 x 2165	105/69 - 125/89
2200 x 2000	4520 x 2065	105/69 - 125/89
2200 x 2100	4520 x 2165	105/69 - 125/89
2400 x 2000	4920 x 2065	105/69 - 125/89
2400 x 2100	4920 x 2165	105/69 - 125/89

PER INTONACO FUORI MISURA FOR EXTRA HEIGHT PLASTERED WALLS		anta doppia double
Luce di passaggio "L x H" Clear opening size "L x H"	Misure d'ingombro "Li x Hi" Structural opening size "Li x Hi"	Parete finita/Sede interna "Pf x Si" Finished wall/Internal space "Pf x Si"
1200 x 800÷1990	2520 x 865÷2055	105/69 - 125/89
1200 x 2010÷2090	2520 x 2075÷2155	105/69 - 125/89
1400 x 800÷1990	2920 x 865÷2055	105/69 - 125/89
1400 x 2010÷2090	2920 x 2075÷2155	105/69 - 125/89
1600 x 800÷1990	3320 x 865÷2055	105/69 - 125/89
1600 x 2010÷2090	3320 x 2075÷2155	105/69 - 125/89
1800 x 800÷1990	3720 x 865÷2055	105/69 - 125/89
1800 x 2010÷2090	3720 x 2075÷2155	105/69 - 125/89
2000 x 800÷1990	4120 x 865÷2055	105/69 - 125/89
2000 x 2010÷2090	4120 x 2075÷2155	105/69 - 125/89
2200 x 800÷1990	4520 x 865÷2055	105/69 - 125/89
2200 x 2010÷2090	4520 x 2075÷2155	105/69 - 125/89
2400 x 800÷1990	4920 x 865÷2055	105/69 - 125/89
2400 x 2010÷2090	4920 x 2075÷2155	105/69 - 125/89

PER INTONACO FUORI MISURA FOR EXTRA HEIGHT PLASTERED WALLS		anta doppia double
Luce di passaggio "L x H" Clear opening size "L x H"	Misure d'ingombro "Li x Hi" Structural opening size "Li x Hi"	Parete finita/Sede interna "Pf x Si" Finished wall/Internal space "Pf x Si"
1200 x 2110÷2700	2520 x 2175÷2765	105/69 - 125/89
1400 x 2110÷2700	2920 x 2175÷2765	105/69 - 125/89
1600 x 2110÷2700	3320 x 2175÷2765	105/69 - 125/89
1800 x 2110÷2700	3720 x 2175÷2765	105/69 - 125/89
2000 x 2110÷2700	4120 x 2175÷2765	105/69 - 125/89
2200 x 2110÷2700	4520 x 2175÷2765	105/69 - 125/89
2400 x 2110÷2700	4920 x 2175÷2765	105/69 - 125/89

Prima di ordinare la porta per il contro telaio Essential è necessario verificare in cantiere l'effettiva misura della luce. Essa si rileva ad installazione avvenuta del contro telaio.

Before ordering the door for the Essential frame, the effective clear opening size must be checked onsite. This must be measured after the installation of the frame.

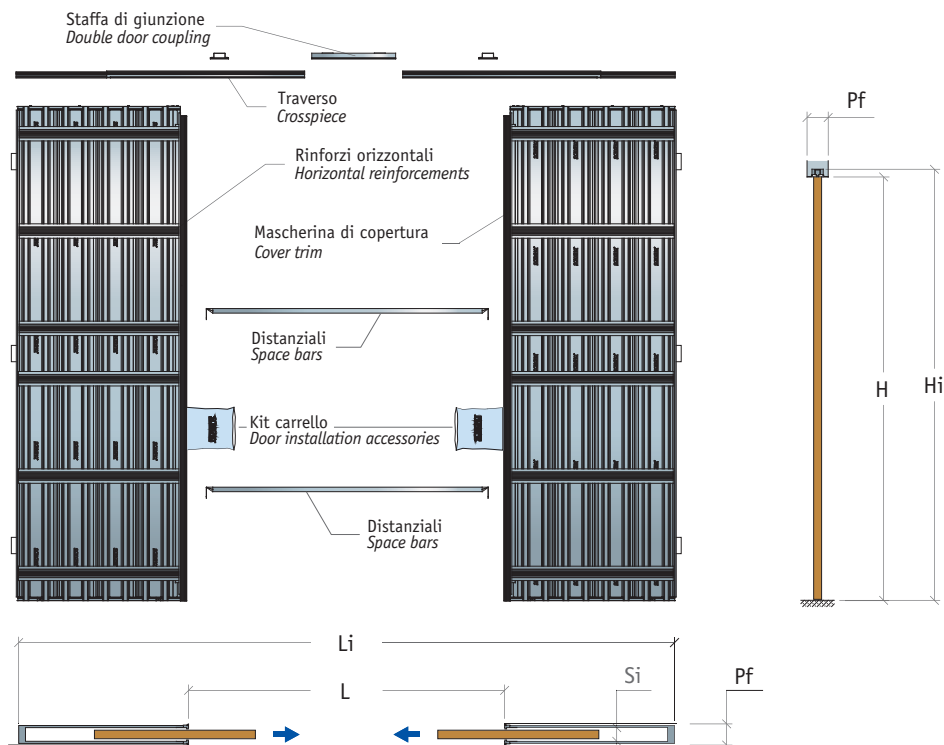

ANTA DOPPIA PER PARETI IN CARTONGESSO FOR PLASTERBOARD WALLS, DOUBLE

PER CARTONGESSO FOR PLASTERBOARD WALLS

anta doppia
double

Luce di passaggio "L x H" Clear opening size "L x H"	Misure d'ingombro "Li x Hi" Structural opening size "Li x Hi"	Parete finita/Sede interna "Pf x Si" Finished wall/Internal space "Pf x Si"
1200 x 2000	2520 x 2065	100/54 - 125/69
1200 x 2100	2520 x 2165	100/54 - 125/69
1400 x 2000	2920 x 2065	100/54 - 125/69
1400 x 2100	2920 x 2165	100/54 - 125/69
1600 x 2000	3320 x 2065	100/54 - 125/69
1600 x 2100	3320 x 2165	100/54 - 125/69
1800 x 2000	3720 x 2065	100/54 - 125/69
1800 x 2100	3720 x 2165	100/54 - 125/69
2000 x 2000	4120 x 2065	100/54 - 125/69
2000 x 2100	4120 x 2165	100/54 - 125/69
2200 x 2000	4520 x 2065	125/69
2200 x 2100	4520 x 2165	125/69
2400 x 2000	4920 x 2065	125/69
2400 x 2100	4920 x 2165	125/69

LEGENDA LEGEND

- L = Larghezza luce
Opening Width
- H = Altezza luce
Opening Height
- Li = Ingombro in larghezza
Overall Width
- Hi = Ingombro in altezza
Overall Height
- Pf = Parete finita
Finished Wall
- Si = Sede interna
Internal Space

PER CARTONGESSO FUORI MISURA FOR EXTRA HEIGHT PLASTERBOARD WALLS

anta doppia
double

Luce di passaggio "L x H" Clear opening size "L x H"	Misure d'ingombro "Li x Hi" Structural opening size "Li x Hi"	Parete finita/Sede interna "Pf x Si" Finished wall/Internal space "Pf x Si"
1200 x 800÷1990	2520 x 865÷2055	100/54 - 125/69
1200 x 2010÷2090	2520 x 2075÷2155	100/54 - 125/69
1400 x 800÷1990	2920 x 865÷2055	100/54 - 125/69
1400 x 2010÷2090	2920 x 2075÷2155	100/54 - 125/69
1600 x 800÷1990	3320 x 865÷2055	100/54 - 125/69
1600 x 2010÷2090	3320 x 2075÷2155	100/54 - 125/69
1800 x 800÷1990	3720 x 865÷2055	100/54 - 125/69
1800 x 2010÷2090	3720 x 2075÷2155	100/54 - 125/69
2000 x 800÷1990	4120 x 865÷2055	100/54 - 125/69
2000 x 2010÷2090	4120 x 2075÷2155	100/54 - 125/69
2200 x 800÷1990	4520 x 865÷2055	125/69
2200 x 2010÷2090	4520 x 2075÷2155	125/69
2400 x 800÷1990	4920 x 865÷2055	125/69
2400 x 2010÷2090	4920 x 2075÷2155	125/69

PER CARTONGESSO FUORI MISURA FOR EXTRA HEIGHT PLASTERBOARD WALLS

anta doppia
double

Luce di passaggio "L x H" Clear opening size "L x H"	Misure d'ingombro "Li x Hi" Structural opening size "Li x Hi"	Parete finita/Sede interna "Pf x Si" Finished wall/Internal space "Pf x Si"
1200 x 2110÷2400	2520 x 2175÷2465	125/69
1400 x 2110÷2400	2920 x 2175÷2465	125/69
1600 x 2110÷2400	3320 x 2175÷2465	125/69
1800 x 2110÷2400	3720 x 2175÷2465	125/69
2000 x 2110÷2400	4120 x 2175÷2465	125/69
2200 x 2110÷2400	4520 x 2175÷2465	125/69
2400 x 2110÷2400	4920 x 2175÷2465	125/69

Prima di ordinare la porta per il contro telaio Essential è necessario verificare in cantiere l'effettiva misura della luce. Essa si rileva ad installazione avvenuta del contro telaio.

Before ordering the door for the Essential frame, the effective clear opening size must be checked onsite. This must be measured after the installation of the frame.

CONTROTELAIA
COUNTERFRAMES



Brevetto esclusivo Scigno, Essential Dual è il controtelaio nato dall'evoluzione di Essential e Granluce. Si tratta di un prodotto innovativo, un unico cassonetto, permette di contenere al suo interno due porte in vetro scorrevoli a scomparsa collegate tra loro da un sistema di trascinamento. La particolarità consiste nello spessore parete ridotto: è utilizzabile in presenza di una normale parete con spessore di 10,5 cm e lo spessore delle ante in vetro è di 1 cm. Il telaio è stato ridotto all'essenziale eliminando stipiti e cornici coprifilo.

È disponibile solo nella versione anta unica per pareti in muratura. Disponibile anche in versione fuori misura con altezze variabili al centimetro.

An exclusive Scigno patent, Essential Dual is a frame based on an evolution of the Essential and Granluce models, and is an innovative product that can contain two disappearing glass doors linked by a sliding system inside a single metal box. The special feature of Essential Dual is that it can be built into a normal wall with a thickness of just 10.5 cm, and the glass doors have a thickness of 1 cm. The frame has been reduced to the minimum essential, eliminating door posts and edging trims.

Available only in the single-door version for masonry walls. Also available in non-standard sizes with heights variable in steps of 1 cm.

ESSENTIAL DUAL





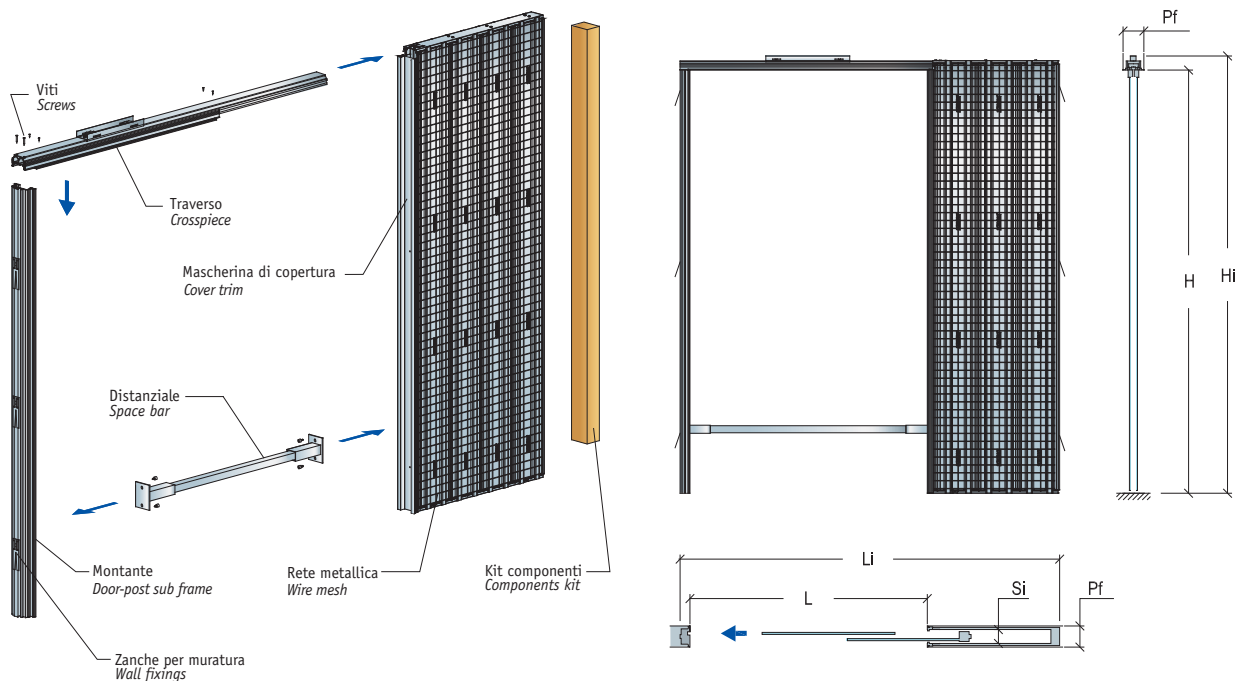

SEMPLICE PER PARETI INTONACABILI FOR PLASTERED WALLS, SIMPLE

PER INTONACO FOR PLASTERED WALLS

semplice
simple

Luce di passaggio "L x H" Clear opening size "L x H"	Misure d'ingombro "Li x Hi" Structural opening size "Li x Hi"	Parete finita/Sede interna "Pf x Si" Finished wall/Internal space "Pf x Si"
1200 x 2000	1910 x 2070	105/69
1200 x 2100	1910 x 2170	105/69
1400 x 2000	2210 x 2070	105/69
1400 x 2100	2210 x 2170	105/69
1600 x 2000	2510 x 2070	105/69
1600 x 2100	2510 x 2170	105/69

PER INTONACO FUORI MISURA FOR EXTRA HEIGHT PLASTERED WALLS

semplice
simple

Luce di passaggio "L x H" Clear opening size "L x H"	Misure d'ingombro "Li x Hi" Structural opening size "Li x Hi"	Parete finita/Sede interna "Pf x Si" Finished wall/Internal space "Pf x Si"
1200 x 2010÷2090	1910 x 2080÷2160	105/69
1200 x 2110÷2400	1910 x 2180÷2470	105/69
1400 x 2010÷2090	2210 x 2080÷2160	105/69
1400 x 2110÷2400	2210 x 2180÷2470	105/69
1600 x 2010÷2090	2510 x 2080÷2160	105/69
1600 x 2110÷2400	2510 x 2180÷2470	105/69

Prima di ordinare la porta per il controtelesia Essential Dual è necessario verificare in cantiere l'effettiva misura della luce. Essa si rileva ad installazione avvenuta del controtelesia.

Before ordering the door for the Essential Dual frame, the effective clear opening size must be checked onsite. This must be measured after the installation of the frame.

La luce di passaggio effettiva a porta installata è ridotta in larghezza di mm 140.

The effective clear opening size with the door installed is reduced in width by 140 mm.



Spessore 10.5 cm
Thickness 10.5 cm



LEGENDA
LEGEND

- L = Larghezza luce
Opening Width
- H = Altezza luce
Opening Height
- Li = Ingombro in larghezza
Overall Width
- Hi = Ingombro in altezza
Overall Height
- PF = Parete finita
Finished Wall
- Si = Sede interna
Internal Space



Le particolari caratteristiche del controtelaio Essential Dual rendono indispensabile l'abbinamento o con la sua porta vetro finita, oppure con la sua specifica ferramenta.

The special characteristics of the Essential Dual frame make it essential for it to be combined with the finished glass door or its specific hardware fittings.

PORTE - DOORS



Le porte della linea Essential by Scigno rappresentano un sistema di porte a filo parete che non necessitano di cornice coprifilo e con cerniere a scomparsa regolabili su 3 assi. La particolarità delle porte Essential è la possibilità di dar continuità agli ambienti, i pannelli porta possono essere verniciati, laccati o ricoperti con carte da parati esattamente come le finiture già esistenti. Due sono le varianti disponibili: Essential Battente, che presenta la classica fuga tra anta e telaio ed Essential Battente Zero, la versione senza fuga. Le porte Essential possono essere installate sia in pareti in muratura che in cartongesso.

The doors of the Essential by Scigno range are a line of doors fitted flush with the wall without edging trims, and with concealed hinges adjustable in 3 directions. The special feature of Essential doors is that they can give a sense of continuity to spaces, and the door panels can be painted, lacquered or covered with wallpaper exactly like the finishes already existing. The two versions available are Essential Battente, with a slight gap between the frame and door, and Essential Battente Zero, the gapless model. Essential doors can be installed on both masonry and plasterboard walls.

ESSENTIAL BATTENTE E BATTENTE ZERO





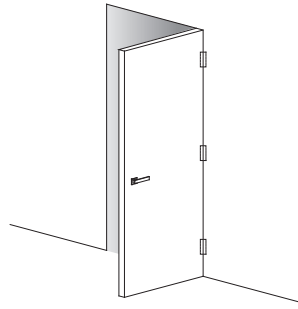

ESSENTIAL BATTENTE STANDARD
ESSENTIAL BATTENTE STANDARD SIZE

Luca di passaggio "L x H" Clear opening size "L x H"	Misure d'ingombro "Li x Hi" Structural opening size "Li x Hi"	Parete finita "Sp" Finished Wall "Sp"
700 x 2000	830 x 2065	105*
700 x 2100	830 x 2165	105*
800 x 2000	930 x 2065	105*
800 x 2100	930 x 2165	105*
900 x 2000	1030 x 2065	105*
900 x 2100	1030 x 2165	105*

* Si utilizza anche per la parete 100 cartongesso - *Can also be used for 100 mm plasterboard walls*
 E' disponibile anche la forma trapezoidale - *Is available a special trapezoidal shape*

ESSENTIAL BATTENTE FUORI MISURA
ESSENTIAL BATTENTE EXTRA HEIGHT

Luca di passaggio - Clear opening size		Misure d'ingombro - Structural opening size		Parete finita "Sp" Finished Wall "Sp"
Larghezza - Width L	Altezza - Height H	Larghezza - Width Li	Altezza - Height Hi	
600	da 1800 a 2700	730	da 1865 a 2765	90 - 105* e oltre/and over 105
700	da 1800 a 2700	830	da 1865 a 2765	90 - 105* e oltre/and over 105
750	da 1800 a 2700	880	da 1865 a 2765	90 - 105* e oltre/and over 105
800	da 1800 a 2700	880	da 1865 a 2765	90 - 105* e oltre/and over 105
900	da 1800 a 2700	1030	da 1865 a 2765	90 - 105* e oltre/and over 105
1000	da 1800 a 2700	1030	da 1865 a 2765	90 - 105* e oltre/and over 105
1100	da 1800 a 2700	1230	da 1865 a 2765	90 - 105* e oltre/and over 105

* Si utilizza anche per la parete 100 cartongesso - *Can also be used for 100 mm plasterboard walls*
 E' disponibile anche la forma trapezoidale - *Is available a special trapezoidal shape*

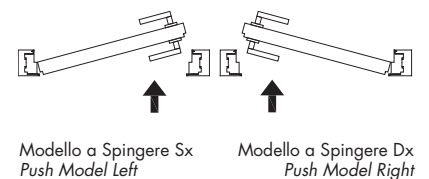
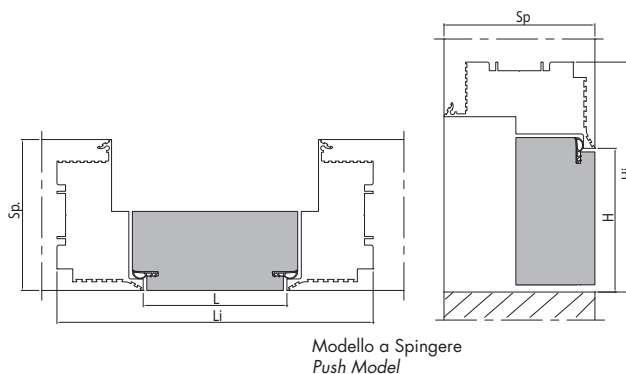
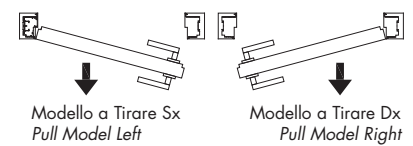
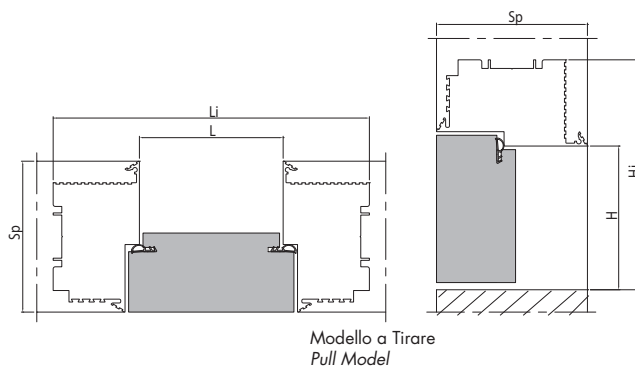

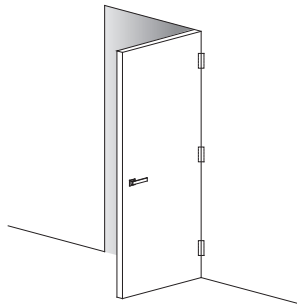

LEGENDA - LEGEND

- L = Larghezza luce
Opening Width
- H = Altezza luce
Opening Height
- Li = Ingombro in larghezza
Overall Width
- Hi = Ingombro in altezza
Overall Height
- SP = Parete finita
Finished Wall

ESSENTIAL BATTENTE ZERO
ESSENTIAL BATTENTE ZERO

Luce di passaggio "L x H" <i>Clear opening size "L x H"</i>	Misure d'ingombro "Li x Hi" <i>Structural opening size "Li x Hi"</i>	Parete finita "Sp" <i>Finished Wall "Sp"</i>
600 x 2000	730 x 2065	105*
600 x 2100	730 x 2165	105*
700 x 2000	830 x 2065	105*
700 x 2100	830 x 2165	105*
750 x 2000	880 x 2065	105*
750 x 2100	880 x 2165	105*
800 x 2000	930 x 2065	105*
800 x 2100	930 x 2165	105*
900 x 2000	1030 x 2065	105*
900 x 2100	1030 x 2165	105*

* Si utilizza anche per la parete 100 cartongesso - *Can also be used for 100 mm plasterboard walls*

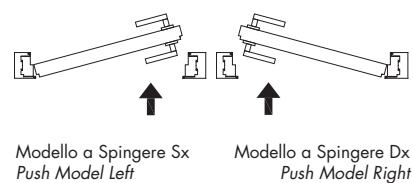
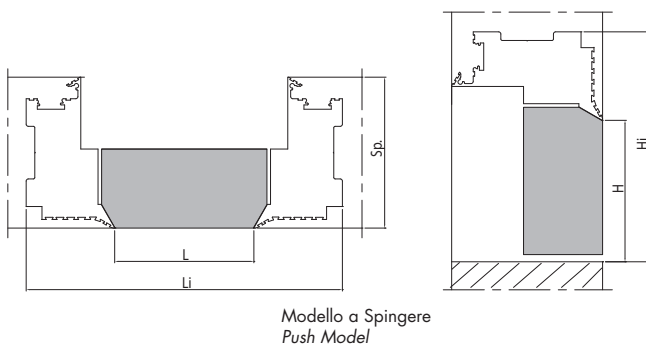
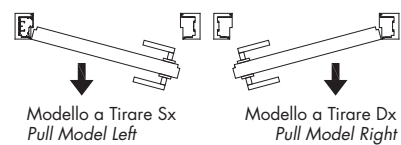
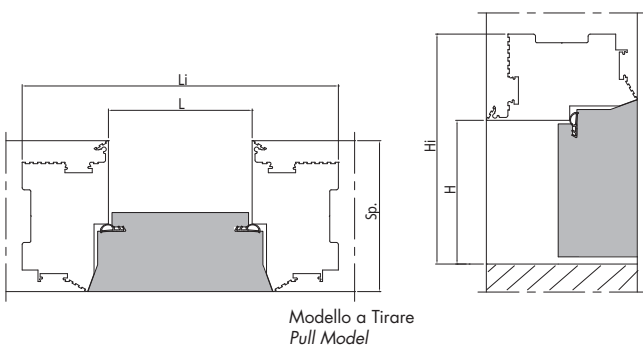

PICCOLI VANI
SMALL SPACES

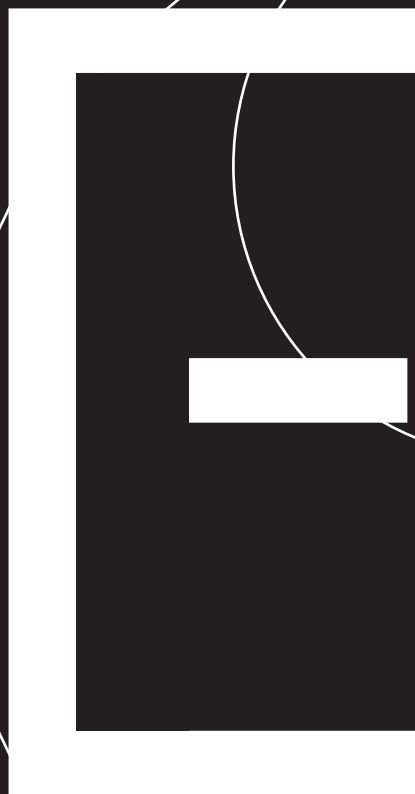

I modelli delle linee Essential Little rappresentano un sistema di sportelli filo parete che non richiedono l'utilizzo di cornici coprifilo e sono pensati come chiusure speciali per piccoli vani. I pannelli possono essere verniciati, laccati o ricoperti con carte da parati esattamente come le finiture già esistenti.

Disponibili in tre modelli: Essential Little che presenta la fuga tra sportello e telaio, Essential Little Zero la variante senza fuga ed Essential Little Cartongesso particolari botole e sportelli d'ispezione, nate specificatamente per le pareti in cartongesso e realizzate interamente in cartongesso (telaio e coperchio).

Essential Little e Little Zero possono essere installati in pareti di qualsiasi spessore sia in muratura sia in cartongesso.

The articles of the Essential Little range are a line of small doors fitted flush with the wall without edging trims, and designed to provide special closures for small spaces. The panels can be painted, lacquered or covered with wallpaper exactly like the finishes already existing.

Available in three models: Essential Little with a small gap between the closure panel and the frame, Essential Little Zero with no gap, and Essential Little Plasterboard, a series of special trapdoors and inspection hatches designed specifically for plasterboard walls and made entirely from plasterboard (frame and cover).

Essential Little and Little Zero can be installed on walls of any thickness, in either masonry or plasterboard.

ESSENTIAL LITTLE





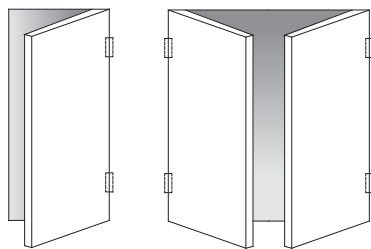

Apertura laterale - Side opening

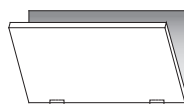

Apertura a ribalta
Upwards opening

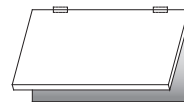

Apertura a vasistas
Downwards opening

Apertura laterale - Horizontal opening

ESSENTIAL LITTLE CON APERTURA LATERALE 1 ANTA ESSENTIAL LITTLE WITH SIDE OPENING, 1 DOOR

Dimensione vano "L x H"
Opening dimensions "L x H"

Dimensione telaio "Li x Hi"
Frame dimensions "Li x Hi"

300 x 400	370 x 470
400 x 600	470 x 670
500 x 1000	570 x 1070

E' disponibile anche la forma trapezoidale
Is available a special trapezoidal shape

ESSENTIAL LITTLE FUORI MISURA CON APERTURA LATERALE 1 ANTA ESSENTIAL LITTLE, EXTRA HEIGHT, WITH SIDE OPENING, 1 DOOR

Dimensione vano - Opening dimensions

Dimensione telaio - Frame dimensions

Larghezza - Width L	Altezza - Height H	Larghezza - Width L	Altezza - Height H
da 300 a 600	da 300 a 1500	da 370 a 670	da 370 a 1570

E' disponibile anche la forma trapezoidale
Is available a special trapezoidal shape

ESSENTIAL LITTLE FUORI MISURA CON APERTURA LATERALE 2 ANTE ESSENTIAL LITTLE, EXTRA HEIGHT, WITH SIDE OPENING, 2 DOORS

Dimensione vano - Opening dimensions

Dimensione telaio - Frame dimensions

Larghezza - Width L	Altezza - Height H	Larghezza - Width L	Altezza - Height H
da 600 a 1200	da 300 a 1500	da 670 a 1270	da 370 a 1570

E' disponibile anche la forma trapezoidale
Is available a special trapezoidal shape

ESSENTIAL LITTLE CON APERTURA ORIZZONTALE 1 ANTA ESSENTIAL LITTLE WITH HORIZONTAL OPENING, 1 DOOR

Dimensione vano - Opening dimensions

Dimensione telaio - Frame dimensions

Larghezza - Width L	Altezza - Height H	Larghezza - Width L	Altezza - Height H
da 300 a 2400	da 300 a 800	da 370 a 2470	da 370 a 870

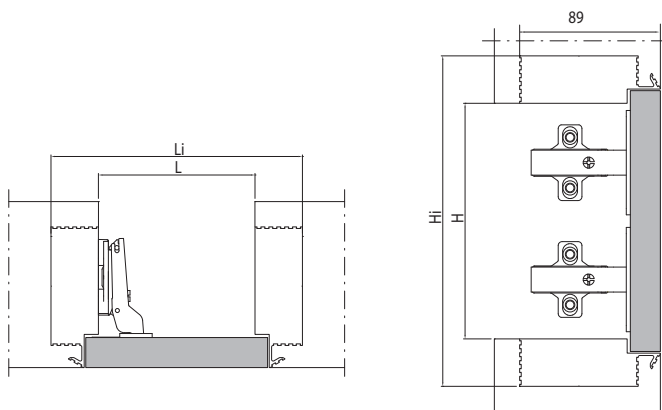

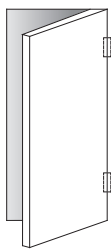

Apertura laterale - Side opening

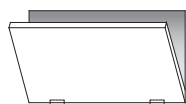

Apertura a ribalta
Upwards opening

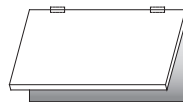

Apertura a vasistas
Downwards opening

Apertura laterale - Horizontal opening

ESSENTIAL LITTLE ZERO CON APERTURA LATERALE 1 ANTA
ESSENTIAL LITTLE ZERO WITH SIDE OPENING, 1 DOOR

Dimensione vano "L x H"
Opening dimensions "L x H"

Dimensione telaio "Li x Hi"
Frame dimensions "Li x Hi"

300 x 400	370 x 470
400 x 600	470 x 670
500 x 1000	570 x 1070

LEGENDA - LEGEND

- L = Larghezza luce
Opening Width
- H = Altezza luce
Opening Height
- Li = Ingombro in larghezza
Overall Width
- Hi = Ingombro in altezza
Overall Height

ESSENTIAL LITTLE ZERO FUORI MISURA CON APERTURA LATERALE 1 ANTA
ESSENTIAL LITTLE ZERO, EXTRA HEIGHT, WITH SIDE OPENING, 1 DOOR

Dimensione vano - Opening dimensions

Dimensione telaio - Frame dimensions

Larghezza - Width L	Altezza - Height H	Larghezza - Width L	Altezza - Height H
da 300 a 600	da 300 a 1300	da 370 a 670	da 370 a 1370

ESSENTIAL LITTLE ZERO CON APERTURA ORIZZONTALE 1 ANTA
ESSENTIAL LITTLE ZERO WITH HORIZONTAL OPENING, 1 DOOR

Dimensione vano - Opening dimensions

Dimensione telaio - Frame dimensions

Larghezza - Width L	Altezza - Height H	Larghezza - Width L	Altezza - Height H
da 300 a 2100	da 300 a 800	da 360 a 2170	da 370 a 870

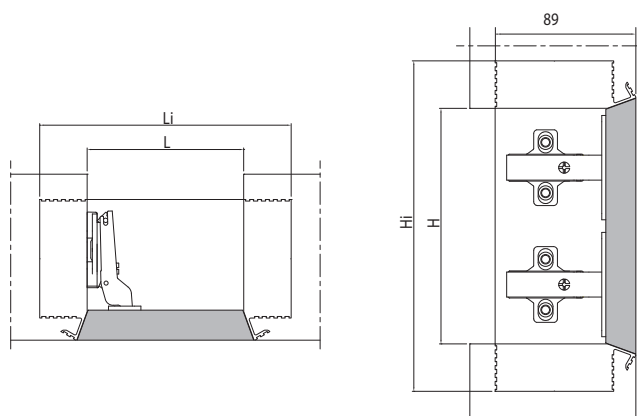



ESSENTIAL LITTLE CARTONGESSO DA SOFFITTO
ESSENTIAL LITTLE PLASTERBOARD FOR CEILING

Dimensione vano "L x H" <i>Opening dimensions "L x H"</i>	Dimensione telaio "Li x Hi" <i>Frame dimensions "Li x Hi"</i>
200 x 200	600 x 600
300 x 300	600 x 600
400 x 400	600 x 600
500 x 500	800 x 800
600 x 600	800 x 800

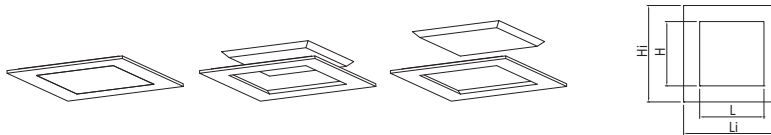

ESSENTIAL LITTLE CARTONGESSO DA PARETE A FISSAGGIO MAGNETICO
ESSENTIAL LITTLE PLASTERBOARD FOR WALL, FIXED MAGNETICALLY

Dimensione vano "L x H" <i>Opening dimensions "L x H"</i>	Dimensione telaio "Li x Hi" <i>Frame dimensions "Li x Hi"</i>
200 x 200	600 x 600
400 x 600	600 x 800
1600 x 300	2000 x 600

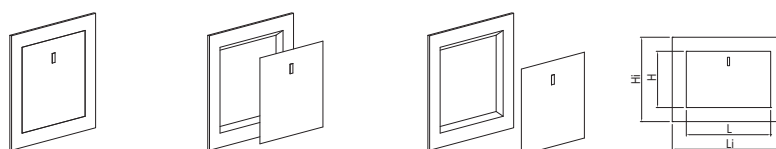

ESSENTIAL LITTLE CARTONGESSO DA PARETE CON CERNIERE 1 ANTA
ESSENTIAL LITTLE PLASTERBOARD FOR WALL, WITH HINGE, 1 DOOR

Dimensione vano "L x H" <i>Opening dimensions "L x H"</i>	Dimensione telaio "Li x Hi" <i>Frame dimensions "Li x Hi"</i>
300 x 400	600 x 800
400 x 600	600 x 800
500 x 1000	800 x 1300

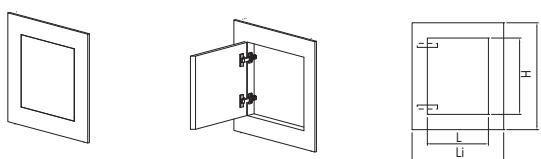

ESSENTIAL LITTLE CARTONGESSO DA PARETE CON CERNIERE 2 ANTE
ESSENTIAL LITTLE PLASTERBOARD FOR WALL, WITH HINGE, 2 DOORS

Dimensione vano "L x H" <i>Opening dimensions "L x H"</i>	Dimensione telaio "Li x Hi" <i>Frame dimensions "Li x Hi"</i>
800 x 1500	1200 x 2000

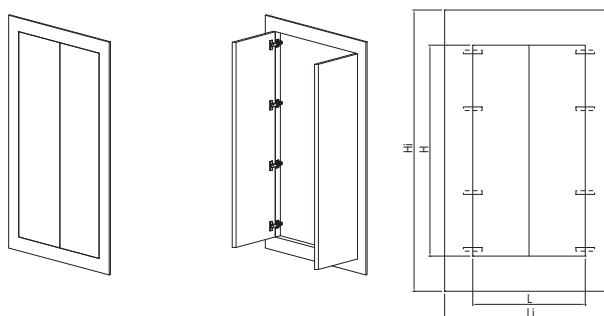

LEGENDA - LEGEND

- L = Larghezza luce
Opening Width
- H = Altezza luce
Opening Height
- Li = Ingombro in larghezza
Overall Width
- Hi = Ingombro in altezza
Overall Height



Solo per l'Italia - Only for Italy

Le fotografie, i disegni, le illustrazioni, le essenze ed i colori hanno valore puramente indicativo. Tutti i modelli possono subire in qualsiasi momento, senza preavviso, qualche lieve variazione nelle sezioni, nella struttura e nel disegno: pertanto, qualora a nostro insindacabile giudizio, resti immutata l'estetica complessiva e la solidità della porta, il Cliente non potrà recedere dal contratto, nè avrà diritto a sconti o abbuoni particolari.
The photographs, drawings, illustrations, types of wood and colours have a purely indicative value. All models may be subject to slight variation at any time, without prior notice, in the sections, structure and design: therefore, should the manufacturer retain that the overall aesthetics and solidity of the door are unchanged, the Customer may not withdraw from the contract, nor have the right to special discounts or allowances.



EEESSENTIAL
by **SCRIGNO**

SCRIGNO Spa
via Casale, 975 - 47822 Sant'Ermete di Santarcangelo (RN) - ITALY
Tel. +39 0541 757711 - Fax +39 0541 757780
e-mail: scrigno@scrigno.it - www.scrigno.net